



EN 50131-1
EN 50131-2-4
EN 50131-5-3
EN 50130-4
EN 50130-5
CEB T031

Air2



Air2-QIR200W Air2-QDT200W

INDOOR WIRELESS PASSIVE INFRARED DETECTOR FOR INTRUSION ALARM SYSTEMS

Air2-QIR200W

Air2-QIR200W is a wireless infrared detector. The device is equipped with an anti-tamper function for protection against opening and dislodgement tamper.

Air2-QDT200W

Air2-QDT200W is a wireless dual technology detector with anti-masking function. The device is equipped with an anti-tamper function for protection against opening, dislodgement and masking tamper.

Both detectors are certified to Security grade 2.



Air2-QIR200W
Air2-QDT200W

TECHNICAL FEATURES

- Digital signal analysis
- Coverage: 13m (for Air2-QIR200W); 10m (for Air2-QDT200W)
- Detection angle: 90°
- Pulse counter
- Temperature compensation
- White light immunity
- Signalling LED
- Signals from bypassable LEDs
- Anti-opening protection
- Movement and tilt protection
- Anti-masking protection (for Air2-QDT200W only)
- Adjustable sensor sensitivity
- Wireless interface Air2

Main features	Air2-QIR200W	Air2-QDT200W
Operating voltage		
Battery type	Lithium CR17450 3V	
Estimated life	3 years	
Stand-by current draw	30µA	50µA
Maximum current draw	30mA	30mA
Detectors type	digital dual PIR	digital dual PIR, microwave module
Detection mode	Infrared emission	Infrared emission + doppler effect
Detection range (max.)	13m	10m
Detection angle	90°	
Security rating	2	
Complies with standards	EN50131-2-2; EN50131-5-3	EN50131-2-4; EN50131-5-3
Environmental class	II	
Installation method	wall-mounting	
Installation height	2.2m	
Dimensions (HxWxD)	120 x 60 x 48 mm	
Weight (with battery)	100g	
Microwave		
Band frequency	–	24.0 – 24.25 GHz
RF output power (max.)	–	<31.62 mW e.i.r.p. (15 dBm)
Operating environmental conditions		
Temperature	from -10 to +40 °C	
Relative humidity	≤93% without condensation	



INSTALLATION

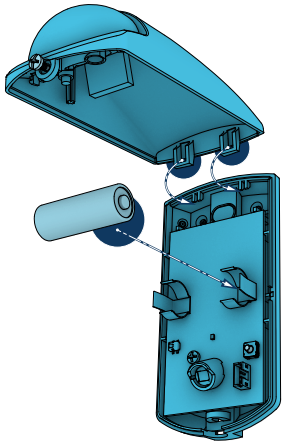

Air2-QIR200W

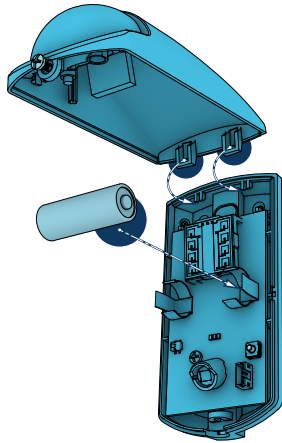

Air2-QDT200W

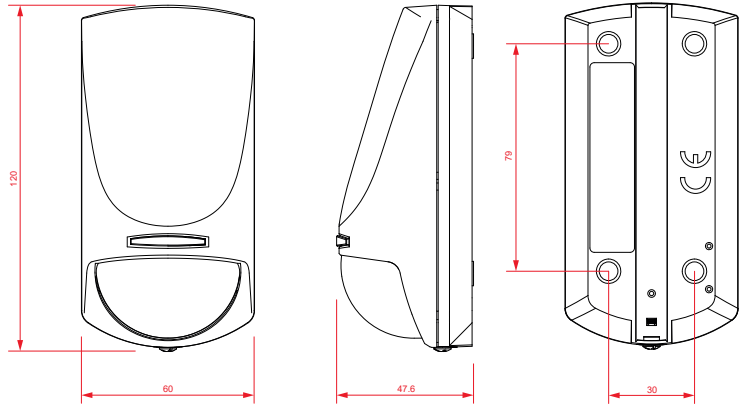

Air2-QIR200W, Air2-QDT200W

Coverage

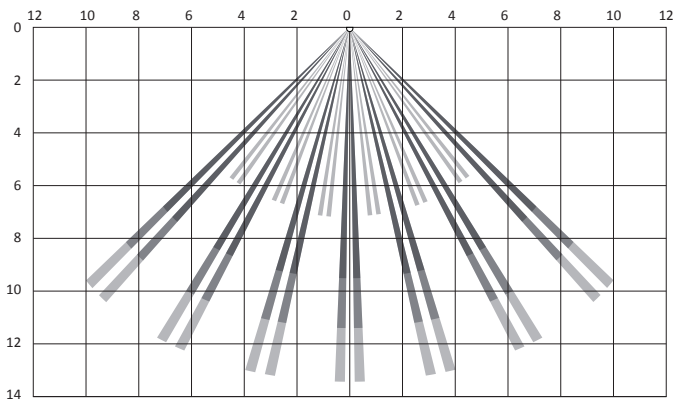

Air2-QIR200W – Top view

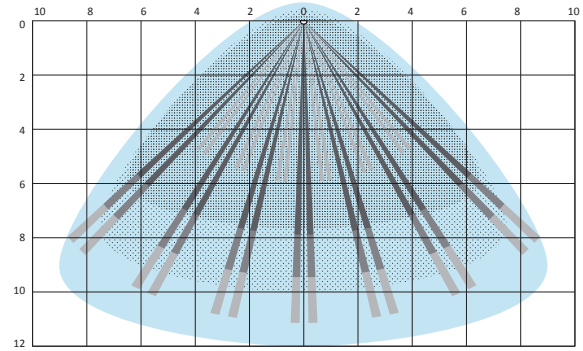

Air2-QDT200W – Top view

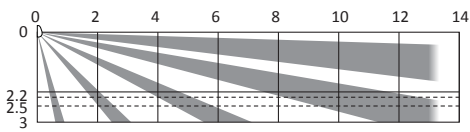

Air2-QIR200W – Side view

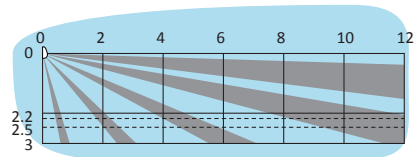

Air2-QDT200W – Side view

ORDER CODES

Air2-QIR200W

Indoor wireless passive infrared detector.

Air2-QDT200W

Indoor wireless combined passive infrared and microwave curtain detector with anti-masking protection.

XBK100

Swivel bracket for QTech detectors.



Centobuchi, via Dei Lavoratori 10
63076, Montepandone (AP), ITALY
Tel. +39 0735 705007 _ Fax +39 0735 704912

info@inim.biz _ www.inim.biz

DCSTINE0A2QXX200W-100-20220426

Inim distributor's stamp and signature