

# ***ENFORCER***<sup>®</sup> ***Sensor***



## ***Retro-Reflective Photoelectric Sensor Entry Alert System***

**E-931CS22RRCQ**

Range: 22ft. (7m)

### **INSTALLATION MANUAL**



#### **Features:**

- Retro-reflective photoelectric sensor.
- Range: Up to 22 feet (7m).
- Perfect for monitoring an entrance, or for counting foot traffic with optional counter.
- Will make “ding-dong” sound or alarm sound when the beam is interrupted.
- Speaker volume can be adjusted or turned off.
- When in alarm mode, sounding time is adjustable from 3 to 30 seconds.
- All components plug into each other. No hard wiring required.
- Optional counter available (E-931ACC-CQ).
- Optional second speaker available (E-931ACC-SQ).
- Includes the following:
  - Retro-reflective photoelectric sensor.
  - Reflector.
  - Speaker/electronic chime.
  - Power adapter.

#### **Caution:**

- This sensor was not designed to prevent bodily injury or loss of life.
- Use of this sensor in certain security applications may be regulated by local laws or codes. SECO-LARM is not responsible for compliance with such laws or codes.

#### **Included:**

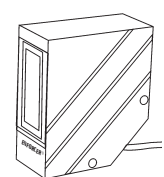

E-931CS22SQ  
Transmitter/Receiver

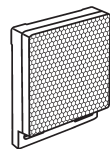

E-931ACC-R2Q  
Reflector

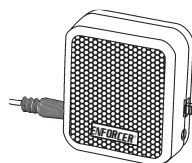

E-931ACC-SQ  
Speaker/Electronic Chime

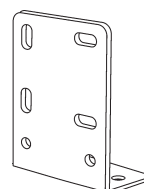

E-931ACC-BLS4Q  
Sensor Bracket

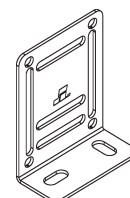

E-931ACC-BLR2Q  
Reflector bracket

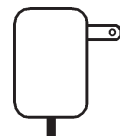

Power  
Adapter

## Optional Accessories:



E-931ACC-SQ  
Speaker/Electronic Chime  
(with 32ft wire)



E-931ACC-CQ  
Digital Counter  
(with 32ft wire)

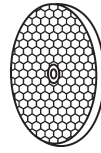

E-931ACC-RC1Q  
Round Reflector  
82 x 9 mm

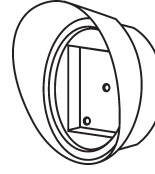

E-931ACC-HR1Q  
Reflector Hood for  
Round/Square Reflectors

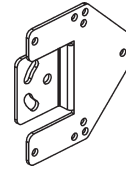

E-931ACC-BLS8Q  
Door Frame Bracke

## Sample Installations:

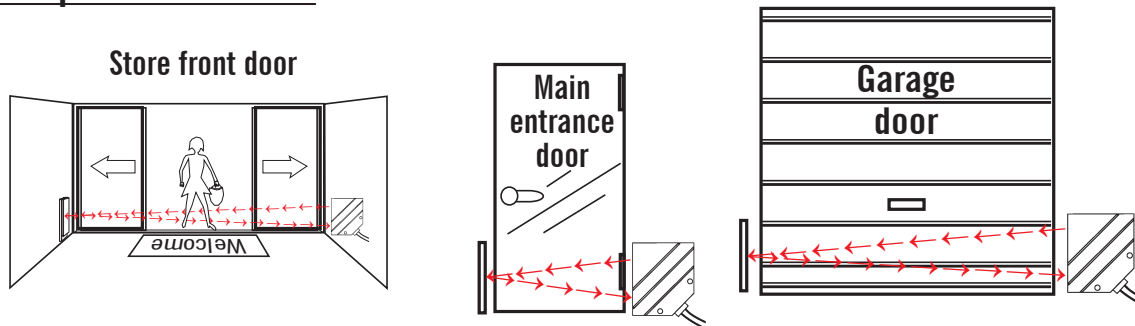

Other possible applications: Offices, stores, schools, warehouse, vehicle detection, etc.

## Wiring: (one speaker, no counter)

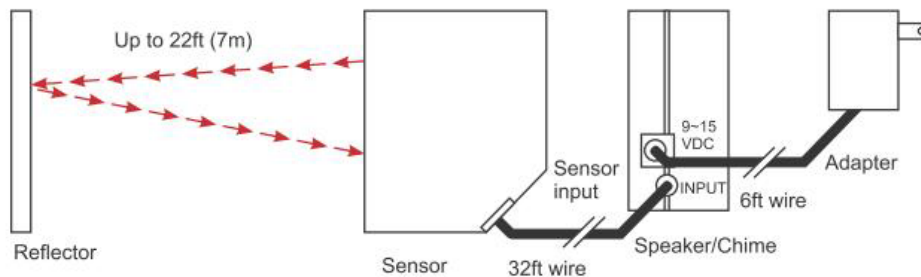

## Wiring: (with optional counter and second speaker)

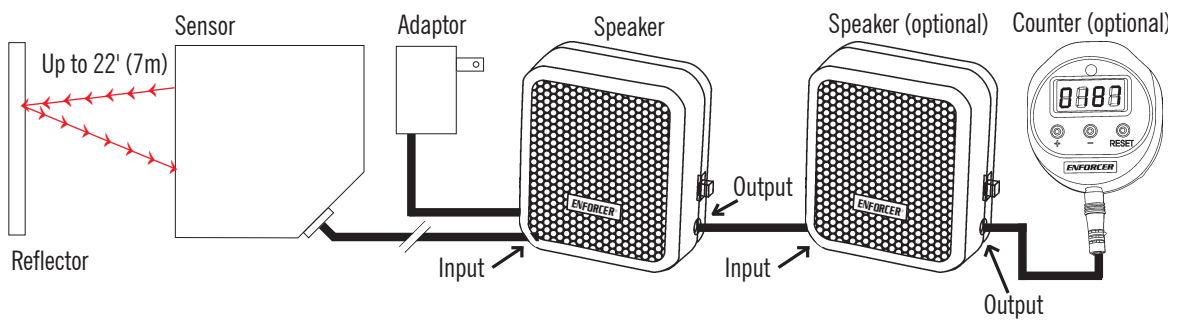

- NOTE:**
- When adding a 2nd speaker. If the application distance between speakers exceed 33 ft. (10m), then a power adaptor is required for the 2nd speaker.
  - When there are 2 devices added to the first speaker, such as a 2nd speaker & a counter. Then a second power adaptor is required for the 2nd speaker even when the distance is within 33 ft. (10m)
  - Speaker and counter uses a standard 1/8" stereo jacks.

## Mounting the Reflector:

Sample Fixed Mounting:

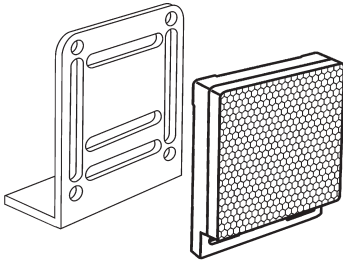

## Mounting the Sensor:

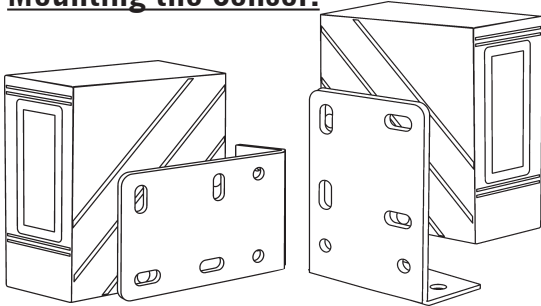

## Installation and Adjustment:

### **LED Functions:**

RED LED - When ON, it indicates the sensor is powered and aligned properly.

### **Installation:**

1. Mount the reflector and sensor so they face each other at about 2' off the ground or knee high.
2. Connect the sensor to the speaker.
3. Connect power adaptor to the speaker.
  - For signalling in multiple rooms, add an optional second speaker (E-931ACC-SQ).
  - Connect an optional counter (E-931ACC-CQ) to the speaker output (if desired).
4. To find the correct alignment, slowly adjust the angles of the sensor and/or reflector up and down and right and left.
5. Do not let sunlight or any direct beam of light enter the sensing spot of the sensor.

**NOTE: Correct alignment is reached when red LED turns ON.**

### **Set Speaker Mode:**

After the sensor and reflector have been properly installed, the next step is to set the speaker mode.

1. Choose between "Chime" or "Alarm" sound or "OFF".
2. If "Alarm" was chosen:
  - A. Set speaker to Alarm
  - B. Adjust the alarm sounding time from 3 to 30 seconds.
  - C. Set speaker Volume.

## Mounting the Speaker/Electronic Chime:

Sample Fixed Mounting:

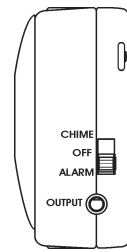

Sample Bracket Mounting:

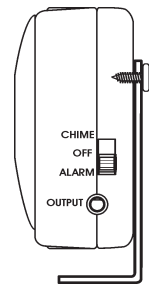

## Adjusting the Speaker/Electronic Chime:

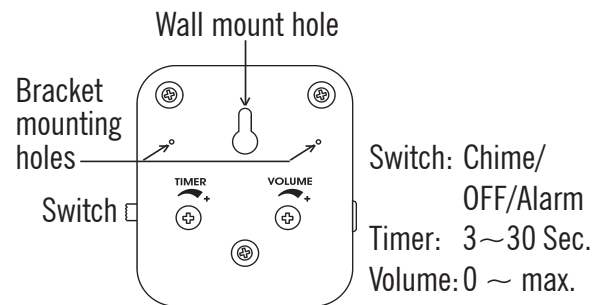

3. If "Chime" was chosen: Set speaker to Chime
4. If "OFF" was chosen:
  - A. Set speaker to OFF
  - B. The speaker will not sound when the beam is broken.

### **Using the Optional Counter:**

1. Automatically increases by "1" when sensor is triggered.
2. Manually add "1" by pressing "+".
3. Manually subtract "1" by pressing "-".
4. Reset counter by pressing "RESET."

### **Testing:**

1. Power up the sensor and speaker. The red LED should be ON.
2. Pass object to be detected between the sensor and reflector. The red LED should turn OFF and the speaker (if connected) should sound.

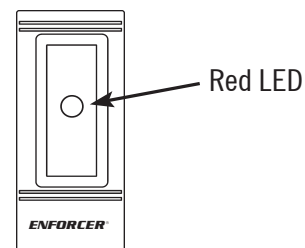

## Specifications:

Model Number	<b>E-931CS22RRCQ</b>
Type	Retro-Reflective Photoelectric Entry Alert System
Sensing Range	22' (7 m)
Voltage Supply	Sensor: 9-15 VDC, Chime: 9-15 VDC
Total Current Consumption	100mA Max.
Stand-by Current	30mA
Light Source	IR LED
Ambient Temperature	-4°F (-20°C) ~ 122°F (50°C)
Speaker Response Time	~1 sec. for Chime, 30 sec. for Alarm
Speaker Volume	Adjustable from 0 ~ 90 dB at 1m (max.)
Alarm Time Range	Adjustable 3~30sec. for alarm
Speaker Output	Chime / Off /Alarm (Select by switch)
Mounting Brackets	All Included

## Troubleshooting:

Trouble	Possible Origin(s)	Remedy(s)
Sensor does not detect the object.	Sensor not aligned properly.	Change the angle of the sensor or reflector.
Red LED does not turn on.	1) Reflector and/or sensor is misaligned. 2) No power.	1) Adjust the reflector and/or sensor for proper alignment 2) Check power adapter and cable.

## Dimensions:

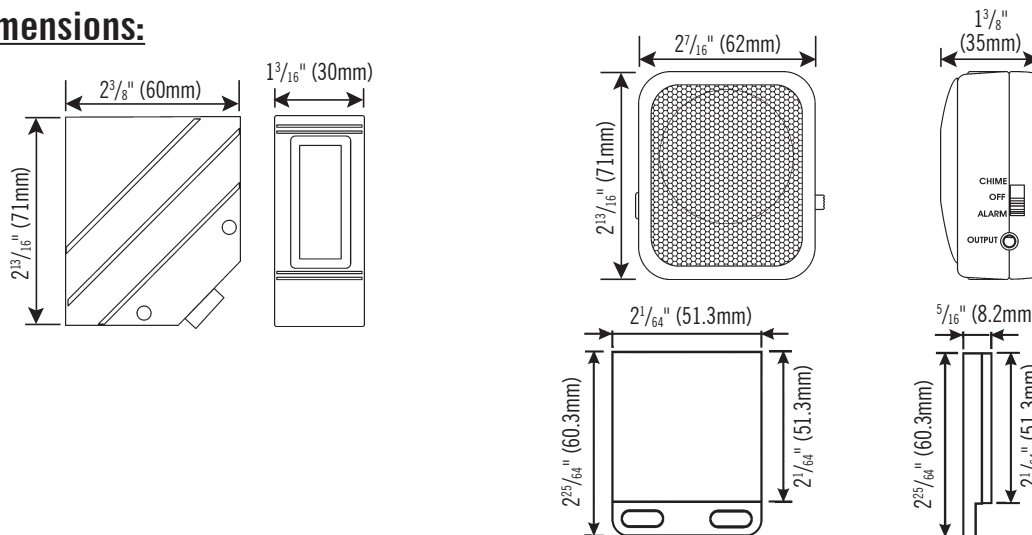

**NOTICE:** The information and specifications printed in this manual are current at the time of publication. However, the SECO-LARM policy is one of continual development and improvement. For this reason, SECO-LARM reserves the right to change specifications without notice. SECO-LARM is also not responsible for misprints or typographical errors. Copyright © 2016 SECO-LARM U.S.A., Inc. All rights reserved. This material may not be reproduced or copied, in whole or in part, without the written permission of SECO-LARM.

**WARRANTY:** ENFORCER Photobeam Sensors are warranted against defects in material and workmanship while used in normal service for a period of one (1) year from the date of sale to the original customer. Our obligation is limited to the repair or replacement of any defective part if the unit is returned, transportation pre-paid, to SECO-LARM.

**SECO-LARM® U.S.A., Inc.**, 16842 Millikan Avenue, Irvine, CA 92606 Tel: 800-662-0800 / 949-261-2999  
 Fax: 949-261-7326 Website: [www.seco-larm.com](http://www.seco-larm.com) E-mail: [sales@seco-larm.com](mailto:sales@seco-larm.com)